

RESONANCE TECHNOLOGIES		
<p><b>JOINT-STOCK COMPANY</b></p> <p><b>SCIENTIFIC-RESEARCH CENTER "IKAR"</b></p> <p><a href="http://www.ikar.udm.ru">http://www.ikar.udm.ru</a></p>	 <p>Gold medal, Geneva. Switzerland, 2004.</p> <p>Silver medal, Brussels, Belgium, 2003.</p> <p>Bronze medal, Geneva. Switzerland, 1994.</p>	<p><b>UDMURT STATE UNIVERSITY</b></p> <p><b>EDUCATIONAL-SCIENTIFIC CENTER</b></p> <p><b>"RESONANCE TECHNOLOGIES"</b></p> <p><a href="http://v4.udsu.ru/science/untsrt">http://v4.udsu.ru/science/untsrt</a></p>
 <p><a href="mailto:ikar@udm.ru">ikar@udm.ru</a></p>	<p>tel./fax. +7 (3412) 76-34-66, Izhevsk, Russia</p>	<p><a href="mailto:svg@uni.udm.ru">svg@uni.udm.ru</a></p> 

## RESONANCE NANOTECHNOLOGIES

The new high-performance breakthrough technologies based on fundamental scientific approach are presented.

### Simple truths, state, and relevance of the problem

- Resonance is the most stable state of movements in the nature. The resonance mechanisms, appliances and resonance technologies have coefficient of efficiency ~100 % and are the most optimal in physics, chemistry, biology and medicine and promissory for engineering, production.
- In resonance a system emits minimally and reserves energy maximally. Under resonance conditions the least expenditure of energy is required for system destruction or stabilization.
- The evolution is going on by transition from one resonance state of movements into another one under influence of the external disturbing factors. Chaos and periodicity are the two sides of one phenomenon – the evolution and time.
- The mathematical strict proof of statement that resonance is the most stable state of movements in the nature follows from the principle of least action and the works of Poincaré A., Lebedev P.N., Ovenden M.V., Shetaev N.G., Blexman I.I., Shironosov V.G. (see <http://www.ikar.udm.ru/sb22.htm>). The principle of least action itself underlies equations and physics laws, wildlife.

Why it is worth to work just with us  $\Sigma(\text{Theory} + \text{Experiment} = \text{Practice})$ .

*“Novel – it is the well forgotten bygone”*

Instead of introduction - brief historical reference.

*In 1989 the group of authors was awarded to the Nobel prize for the non-resonance confinement of charged particles in electrodynamic traps without the feedback. Resonant confinement is considered them till now impossible. In the judgment of foreign experts the given concept means breakthrough in the field of fundamental physics, biophysics and nanotechnologies. In the sequel the new unique methods of diagnostics and nanobiotechnologies (nanoseparation) have been developed by different scientists on the base of life-time study of cell dynamics in nonuniform electromagnetic fields (1994).*

*In 1974 A.I. Filatov and V.G. Shironosov in the USSR theoretically and experimentally (for macrobodies) has been shown an opportunity of resonant confinement of bodies and particles (from elementary up to macro) in non-uniform electromagnetic fields without an external feedback.*

*Decision GCST the USSR 508 from April, 9th, 1991, from the means of the allied budget stipulated for financing of priority directions of scientific and technical progress, are allocated means for carrying out of research and developmental works under the project nanotechnologies - "New technologies on the basis of selective spatial confinement of bodies (from elementary up to macro) without an external feedback in non-uniform fields".*

ГОСУДАРСТВЕННЫЙ КОМИТЕТ СССР ПО НАУКЕ И ТЕХНИКЕ

## ПОСТАНОВЛЕНИЕ

от 9 апреля 1991 г. N 508

О выделении средств союзного бюджета для финансирования научно-исследовательских и опытно-конструкторских работ по государственному заказу

Государственный комитет СССР по науке и технике  
ПОСТАНОВЛЯЕТ:

1. Выделить производственному объединению "Ижевский электро-механический завод" Минрадиопрома СССР на 1991 год для проведения научно-исследовательских и опытно-конструкторских работ по государственному заказу "Новые технологии на основе селективного пространственного удержания тел и частиц (от элементарных до макро) без внешней обратной связи в неоднородных полях" в соответствии с заданием согласно приложению N 1 из средств союзного бюджета, предусмотренных для финансирования приоритетных направлений научно-технического прогресса, 1900 тыс. рублей с распределением согласно приложению N 2.

2. Контроль за выполнением настоящего постановления возложить на Отдел конверсии Комплекса электронизации, приборостроения и связи ГКНТ СССР.

Председатель  
Государственного комитета СССР  
по науке и технике

И. П. Лаверов

## The basic scientific results.

The composite author under the direction of Shironosov V.G. has received a number of essentially new scientific and applied results in the field of resonance influence of fields on nonlinear physical and biological systems (<http://www.ikar.udm.ru/os-resul.htm>):

1. For the first time (1974) theoretically and experimentally (for macro-solids) the possibility of resonance confinement of solids and particles (from elementary till macro) have been demonstrated in nonuniform electromagnetic fields without the external feedback.

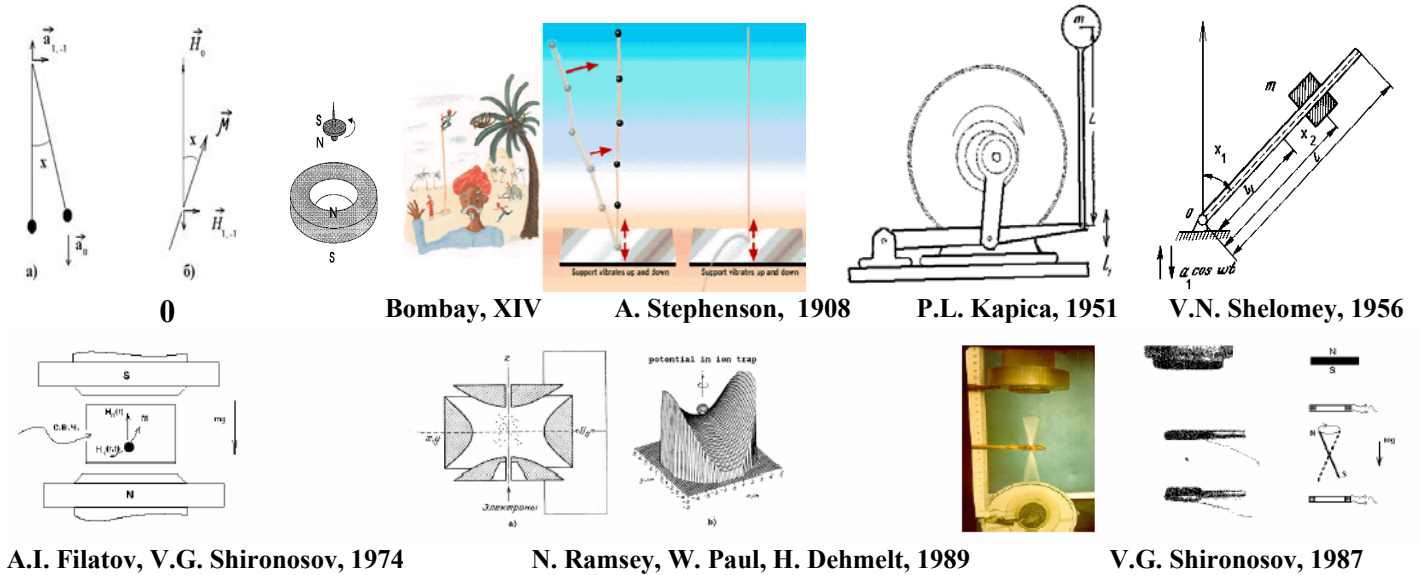

A.I. Filatov, V.G. Shironosov, 1974

N. Ramsey, W. Paul, H. Dehmelt, 1989

V.G. Shironosov, 1987

The method has been developed permitting to find in closed form with necessary accuracy rate the regions of dynamical stability of unstable states of the complex multi-component nonlinear systems of physical nature under resonance conditions and without (1988).

$$x'' + \varepsilon_1 x' + (\varepsilon_0 + \varepsilon_1 \cos \tau) \sin x - \varepsilon_1 \cos(\tau + \varphi) \cos x = 0$$

$$s = \langle L \rangle = (\alpha/2\pi) \int_0^{2\pi\alpha} L d\tau$$

$$S = \sum_{n=1}^{\infty} n^2 \alpha^2 r_n^2 / 4 - y_0^2 / 2 + (1/2) \sum_{k_1, k_2, \dots}^{+\infty} \prod_{n=1}^{+\infty} J_{k_n}(r_n) \sum_{\beta=1}^{+1} \varepsilon_{\beta} \delta_{\sum_{N=1}^{\infty} k_n \alpha}^{\pm \beta} (1 + \delta_{\beta}^0) \cos[x_0 + \sum_{n=1}^{\infty} k_n (\pi/2 - \delta_{\beta}^{\pm 1} \psi_n) - \delta_{\beta}^{-1} (\pi/2 \pm \varphi)]$$

2. For the first time (1984) the problem of “1/R3” was solved theoretically. The possibility of genesis of resonance micro-clusters (RM) – stable resonance conditions of movement in the system from two and more oscillating dipoles at the expense of nonlinear parametric resonance and super-coherent radiation (SR) from RM has been proven.

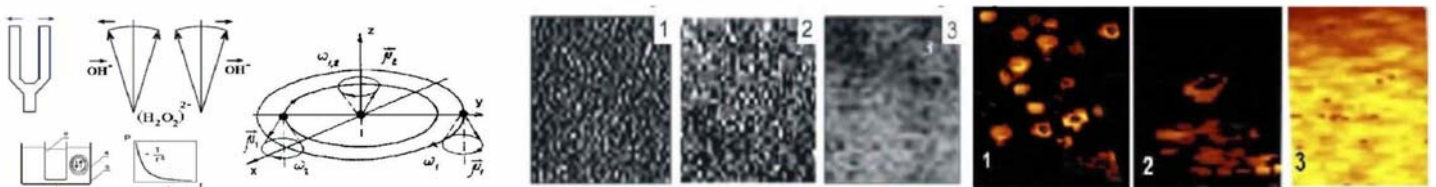

RM (1984)

10-100  $\mu\text{m}$  (2004)

5-100 mm (2007)

3. For the first time the phenomenon of noncontact activation of liquids (БАЖ) at electrolysis without the diaphragm (1999), at chemical (2002) and biochemical (2004, 2006) reactions sustaining existence of PM was discovered experimentally.

4. For the first time (2004) in the world practice the plants have been developed for noncontact resonance activation of liquids awarded to prestige international awards in Switzerland and Brussels.

5. The positive influence of activated mediums (water, air) on the bio-systems (seed sprouting, fishery from berries, cells of blood corpuscle at patient treatment) has been demonstrated (1990-2007).



Accelerations of growth of fishes from caviar.  
<http://www.ikar.udm.ru/sb26-3.htm>



Acceleration enzymatic reaction.  
<http://www.ikar.udm.ru/pr-1.htm>



Acceleration of growth of seeds.  
<http://www.ikar.udm.ru/sb15-2.htm>



Treatment of trophic ulcers, oncological patients.  
<http://www.ikar.udm.ru/sb32-4-2.htm>  
<http://www.ikar.udm.ru/pr-1.htm>



Noncontact activation infusion and dialysis solutions.



6. The unique “Ikar-Test” complex for noncontact registration of dynamics of chemical, biochemical and physical processes in aqueous solutions (2006) has been developed.

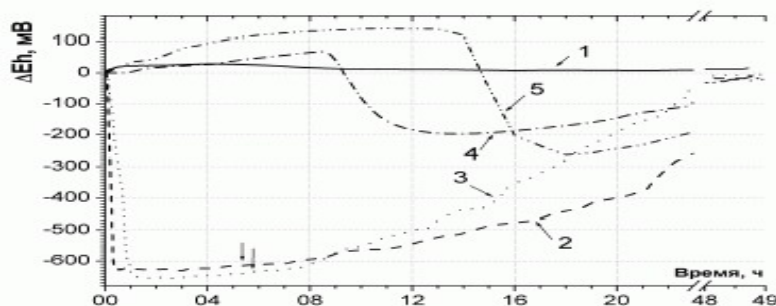
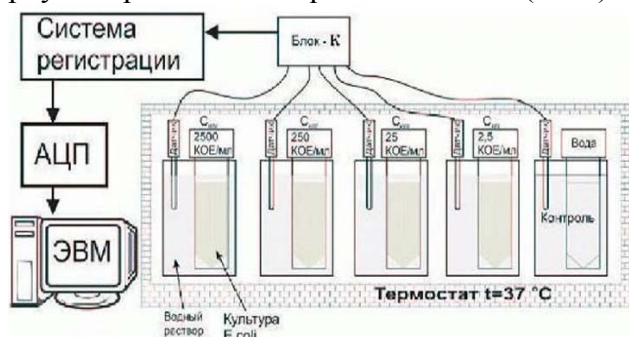

“Ikar-Test” complex for noncontact registration of dynamics of chemical, biochemical and physical processes.

Examples of contactless registration of different processes: 1- infusion solution (IR) 0,9% NaCl (control); 2 - IR at electrolyze without the diaphragm; 3 – dissolution process of microgidrin in H<sub>2</sub>O; 4 – diagnostics of “contamination” of drinking water with E.coli (1 KOE/ml) bacteria; 5 – dynamics of Lactobacillus test in milk.

7. The detection, visualization methods of cluster structure of the liquids have been developed on the base of methods: SHF – spectroscopy (2002), spectrophotometry (2004), and US (ultrasonics) - Doppler tomography (2007).

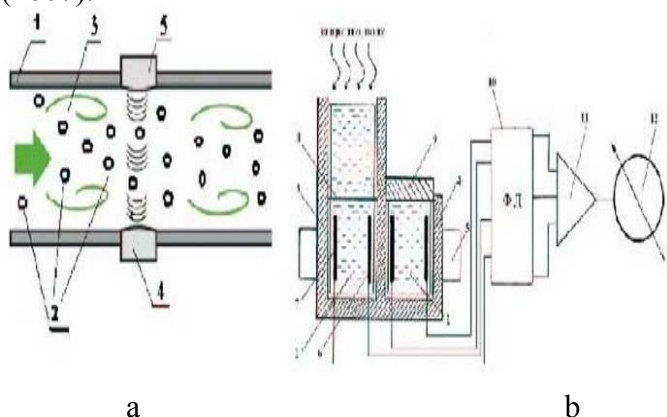

Detection of the cluster structure and micro-clusters of liquid (a) and determination of activity degree of structured liquid (b) (invention application RF №2007127133, 2007127132 from 16.07.2007).

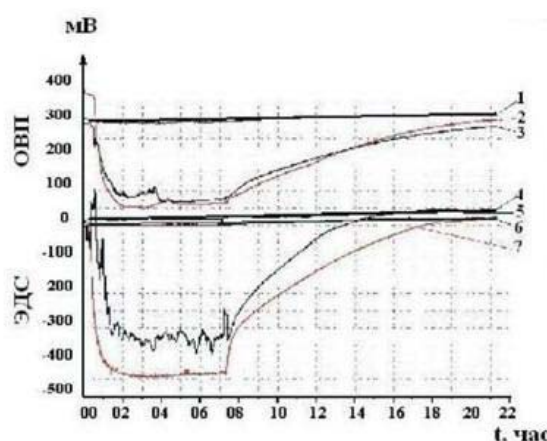

Determination of activity degree of structured liquid by dynamics of Red-Ox - ОБП (1-3), by E - ЭДС (4-6) of samples of distilled water (2, 4, 5) and (1, 3, 6, 7) infusion solution (1, 5, 6 – the control samples, 2, 3, 4, 7 – activated noncontact at electrolyze without the diaphragm).

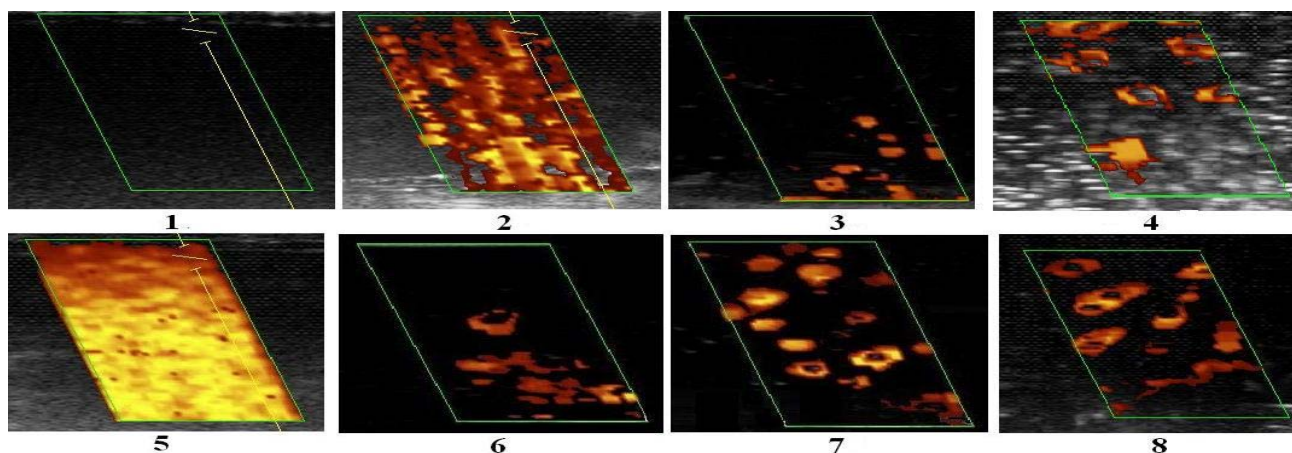

Detection of resonance micro-clusters (5...25 mm) in aqueous solutions: 1- acid anolyte; 2- alkaline catholyte; 3- neutral anolyte cathodal labored ((ANK); 4 – 0,3% aqueous solution  $\text{Na}_2\text{CO}_3$ ; 5 - distilled water; 6 – vodka “Sarapulskay”; 7 and 8 – distilled water; The solutions have been received: (1-3) on the "Izumrud-SI" (mod. 03), (1-2) in the mode of streams anolyte/catholyte 1:1; (4-5) on the "Izumrud-SI" (mod. 04). The solutions have been activated (4) in contact way, (5) contactless; (6) contactless via ultrasonic, (7) by ultraviolet radiation, (8) by gaseous fractions from interaction of Al with HCl solution.

### Patents of RF (№):

- Device for activation of liquid (2299859).
- Device for noncontact activation of liquid (№ 2194017).
- Device for electrochemical treatment of liquid (2076073).
- Device for electrochemical treatment of liquid (2092442).
- The way of crystallization (decision on grant of patent on invention 28.06.2007, № 2004133860).
- The way of determination of activity of structured liquid (application from 16.07.2007, № 2007127132).
- The way of detection of cluster structure and micro-clusters of liquid (application from 16.07.2007, № 2007127133).
- The way of polymer solution preparation (application from 15.08.2006, № 2006129609).
- Device for activation of liquid (application from 20.11.2007, № 2007142957).
- Aeroionizer (variants) (44514).
- Water supply system (0023302).
- Water supply system (0024214).
- Device for electrochemical water treatment (variants) (014654).
- Current stabilizer for device of electrochemical water treatment (014654).
- Device for electroactivation of liquid (variants) (002811).
- Author's certificate. USSR (167981).

### Medals:

- The Gold medal on the International fair “Informatics-Communication-Electronics-2006”. Khabarovsk. Plasmatron.
- The Gold medal on 32-d Salon International Des Invention Geneva-2004. Switzerland. Device for noncontact activation of liquid.
- The Silver medal on the 52-d World Exhibition of Innovation, Research and New Technology “Brussels – Eureka! 2003”. Belgium. Device for contact- noncontact activation of liquids.
- The Bronze medal on 22-d Salon International Des Invention Geneva-2004. Switzerland. Medical complex for treatment and diagnostics on the base of resonance.

### Our investment projects <http://www.ikar.udm.ru/pre.htm>:

1. Resonance technologies <http://www.inno.ru/projects/23369/project23594.shtml>, <http://www.ikar.udm.ru/pr-0.htm>. Resonance nanotechnologies and nanoclusters. <http://www.inno.ru/project/29947/>.
2. Noncontact activation of liquids (infusion and dialysis solutions and medicinal agents, beverages, tea, coffee, drinking water, and among them the therapy tanks, swimming pools; intensification of biotechnologies; prolongation of life-time) - <http://www.ikar.udm.ru/pr-1.htm>, <http://www.inno.ru/projects/23369/project23373.shtml>. Drinking water of superior quality <http://www.inno.ru/project/29499/>.

3. Problem solving of provision the country population with biologically active pure drinking water, disinfectant, sterilizing and detergent solutions - <http://www.ikar.udm.ru/pr-2.htm>.
4. Problem solving of air deionization, dedusting, sterilization - <http://www.ikar.udm.ru/pr-3.htm>.
5. The production chain of devices and environmental safety systems for home, office and hospital - <http://www.ikar.udm.ru/pr-4.htm>, <http://www.inno.ru/projects/23369/project23885.shtml>.
6. Development of laboratory works, education- methodical stands and courses on nonlinear dynamical systems in physics, chemistry and biology for schools and institutes - <http://www.ikar.udm.ru/pr-5.htm>.

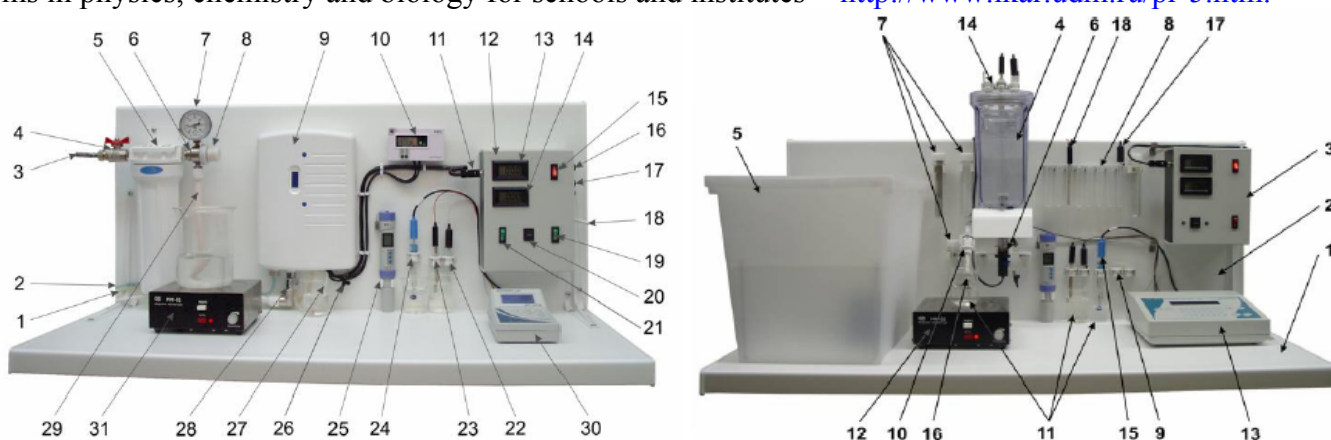

*Education-methodical complexes for contact and noncontact activation of liquids.*

7. Project of autostable plasma ("ball lightnings", by the works of Nikola Tesla and P.L. Kapicha), <http://www.ikar.udm.ru/sb15-9.htm>.

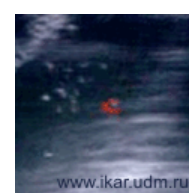
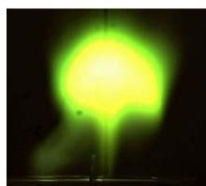

8. The way of receiving the new solid solutions on the base of contactless activation of liquids - <http://www.ikar.udm.ru/pr-7.htm>, <http://www.inno.ru/projects/23369/project23714.shtml>.

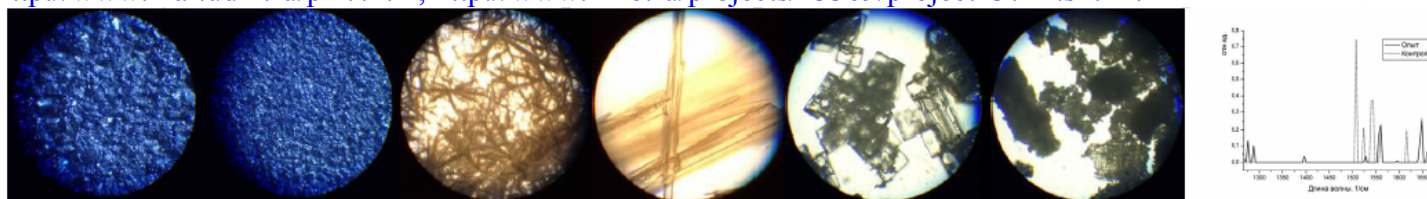

9. The "Ikar-Test" complex for noncontact registration of dynamics of the chemical, biochemical and physical processes in aqueous solutions - <http://www.inno.ru/projects/23369/project23372.shtml>, <http://www.ikar.udm.ru/pr-8.htm>. The rapid method of contactless registration of the chemical, biochemical and physical processes in aqueous solutions - <http://www.inno.ru/project/29847/>.
10. The compact, movable treatment - preventive АВИК-complex (Aero-, Water-, Ion-, extremely high frequencies -treatment) with methods for prevention and treatment with guarantee on the base of resonance influence of fields from ions, molecules, generators on the human <http://www.ikar.udm.ru/avik.htm>.
11. Nanotechnology of receiving the condensed matters with resonance micro-cluster structure on the base of contactless activation of liquids [http://www.kpnm.ru/index.php?option=com\\_bplan&task=show](http://www.kpnm.ru/index.php?option=com_bplan&task=show), [http://www.kpnm.ru/index.php?option=com\\_bplan&task=view&id=86](http://www.kpnm.ru/index.php?option=com_bplan&task=view&id=86).
12. The new supersensitive selective radiation sensor.
13. The new systems of very long-distance propagation of information via super-coherent radiation from RM.
14. The new systems of receiving, wireless transfer and energy storage of superhigh density on the base of RM.
15. Hydrogenous energetics on the base of development of resonance activation of liquid technologies.

## Production of devices and ecological safety systems for home, office and hospital

[http://www.ikar.udm.ru/avk\\_com.htm](http://www.ikar.udm.ru/avk_com.htm)



(mod. 01)



(mod. 02)



(mod. 03)



(mod. 04)



(mod. 01-03)



(mod. 01d)



(mod. 01os)



(mod. 04)



“Vlada”



(mod. 0-n-0)

**Aeroionizer "Lch-1"** (compact household plasmatron – lamp Shigevsky) sanitation appliance for enrichment of house air with light negative ions and compensation of aeroionization insufficiency on the working places of PC users, for aeroionotherapy and air ionization in houses, protection from the “display sickness”  
<http://ikar.udm.ru/aire.htm>.

**Device modification:** **mod. 01** – universal moveable, **mod. 02** – mountable into overhead, building panels, **mod. 03** – mountable into 5" bay of computer system unit, **mod. 04** – desktop variant.

**"Izumrud-SI"** universal device for preparation of drinking water with specified mineral composition and antioxidant properties and for receiving on its base the detergent, disinfectant and sterilizing solutions [http://ikar.udm.ru/w\\_main.htm](http://ikar.udm.ru/w_main.htm).

**Device modification:** **mod. 01** – receiving of drinking ionized water with negative OBI and with specified mineral composition; **mod. 02** – functions of mod. 01 + regulation of pH and OBI; **mod. 03** - mod. 02 + receiving of detergent, disinfectant and sterilizing solutions; *mod 01d* – sharing device on the base of dispensary; **mod. 01os** – for receiving activated drinking water of superior quality with specified mineral composition and antioxidant properties, the device has the built-in controller and three flow-type transducers with two-level indication system - tracking the functioning of osmose (purification), activation (water ionization), mineralization (optimization of mineral composition) systems; **mod. 01 railway** – free-running variant for railway and water passenger transportation, **mod. 04** – universal device for receiving activated liquids with negative Red-Ox (drinking water, beverages, infusion and dialytic solutions, blood) on the base of contactless and contact activation of liquids (ANC, anolyt, catolit...); “Vlada” – electrothermos – an activator for receiving activated water in the house conditions (contact and noncontact activation of aqueous solutions).

**mod. 0-n-0** – device for receiving detergent, disinfecting and sterilizing solutions, disinfection of water in the swimming pools.



(mod. 01-300)

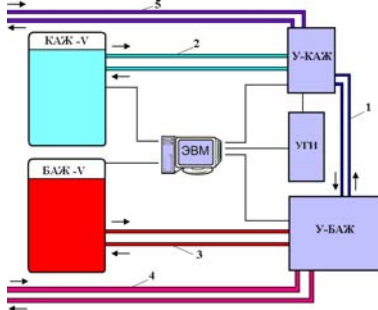

(mod. 04-200)

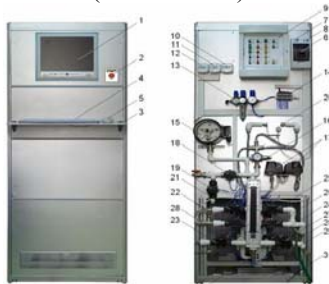

(mod. 4.000)



(mod. 40.000)

**mod. 01-300** – for receiving ionized shower, baths, swimming pools, Jacuzzi, drinking water with negative Red-Ox and with the specified mineral composition.

( $\Delta\text{Red-Ox} \approx -300 \dots -400 \text{ mV}$ ,  $T \approx 4 \dots 400^\circ \text{ C}$ ,  $\Delta V/\Delta t \approx 300 \dots 400 \text{ l/h}$ )

**Module "Energy-Water"** on the base of resonance technologies for receiving from the mineralized (sea, river and artesian) water activated liquids without usage of the chemical reagents and at the minimal expenditure of energy, maintenance and capital.

**PC** - controlling; **У-КАЖ** – device for the contact activation of liquids; **У-БАЖ** – device for the contactless activation of liquids; **УГИ** – the controlled impulse generator; **БАЖ-V**, **КАЖ-V** pools activated liquids; 1,2,3,4 and 5 the lines of (possible) movements of **КАЖ** и **БАЖ**. The variants of activation of the complex: {1,4}; {1,3}; {2,1,3}; {5,1,4}, {1}; {5}; {2}; {2,1,4}.

**Application domains:**

- desalting of (sea, river and artesian) water;
- decontamination of water and aqueous solutions;
- receiving of detergent, disinfecting and sterilizing solutions;
- preparation of drinking water with specified mineral composition and antioxidant properties, with negative Red-Ox from the reference water;
- receiving infusion and dialysis solutions with the antioxidant properties.

**mod. 04-200** – for receiving **КАЖ** and **БАЖ** 200 l/h;

**mod. 4000** – for receiving detergent, disinfecting and sterilizing solutions (АНК, anolyte, catholyte) in automatic mode with capacity from 4 ton per day;

**mod. 40.000** – for water desalting.

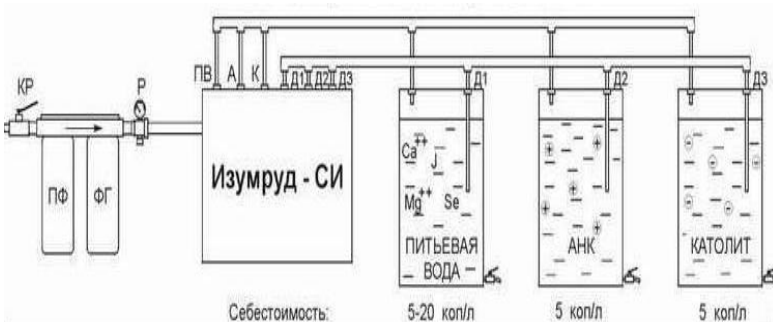

Universal Device "Izumrud-SI" for preparation of drinking water with specified mineral composition and antioxidant properties and for receiving on its base the detergent, disinfecting and sterilizing solutions.